



MIAMI-DADE COUNTY
BUILDING CODE COMPLIANCE OFFICE (BCCO)
PRODUCT CONTROL DIVISION

MIAMI-DADE COUNTY, FLORIDA
METRO-DADE FLAGLER BUILDING
140 WEST FLAGLER STREET, SUITE 1603
MIAMI, FLORIDA 33130-1563
(305) 375-2901 FAX (305) 372-6339

NOTICE OF ACCEPTANCE (NOA)

www.miamidade.gov/buildingcode

High Velocity Hurricane Protection
3390 Mercantile Avenue
Naples, FL 34104

SCOPE:

This NOA is being issued under the applicable rules and regulations governing the use of construction materials. The documentation submitted has been reviewed by Miami-Dade County Product Control Division and accepted by the Board of Rules and Appeals (BORA) to be used in Miami Dade County and other areas where allowed by the Authority Having Jurisdiction (AHJ).

This NOA shall not be valid after the expiration date stated below. The Miami-Dade County Product Control Division (In Miami Dade County) and/or the AHJ (in areas other than Miami Dade County) reserve the right to have this product or material tested for quality assurance purposes. If this product or material fails to perform in the accepted manner, the manufacturer will incur the expense of such testing and the AHJ may immediately revoke, modify, or suspend the use of such product or material within their jurisdiction. BORA reserves the right to revoke this acceptance, if it is determined by Miami-Dade County Product Control Division that this product or material fails to meet the requirements of the applicable building code.

This product is approved as described herein, and has been designed to comply with the Florida Building Code, including the High Velocity Hurricane Zone.

DESCRIPTION: Category 5 Aluminum Hurricane Abatement System – L.M.I.

APPROVAL DOCUMENT: Drawing No. 09-HVH-0001, titled "Category 5 Rolling Hurricane Curtain", prepared by Engineering Express, dated 04/15/09, sheets 1 through 5 of 5, signed and sealed by Frank L. Bennardo, P.E., bearing the Miami-Dade County Product Control approval stamp with the Notice of Acceptance number and approval date by the Miami-Dade County Product Control Division.

MISSILE IMPACT RATING: Large and Small Missile Impact Resistant

LABELING: Each unit shall bear a permanent label with the manufacturer's name or logo, city, state and following statement: "Miami-Dade County Product Control Approved", unless otherwise noted herein.

RENEWAL of this NOA shall be considered after a renewal application has been filed and there has been no change in the applicable building code negatively affecting the performance of this product.

TERMINATION of this NOA will occur after the expiration date or if there has been a revision or change in the materials, use, and/or manufacture of the product or process. Misuse of this NOA as an endorsement of any product, for sales, advertising or any other purposes shall automatically terminate this NOA. Failure to comply with any section of this NOA shall be cause for termination and removal of NOA.

ADVERTISEMENT: The NOA number preceded by the words Miami-Dade County, Florida, and followed by the expiration date may be displayed in advertising literature. If any portion of the NOA is displayed, then it shall be done in its entirety.

INSPECTION: A copy of this entire NOA shall be provided to the user by the manufacturer or its distributors and shall be available for inspection at the job site at the request of the Building Official. This NOA consists of this page 1 and evidence pages E-1 and E-2, as well as approval document mentioned above.

The submitted documentation was reviewed by **Carlos M. Utrera, P.E.**



Carlos M. Utrera
7/22/09

NOA No. 09-0511.02
Expiration Date: August 12, 2014
Approval Date: August 12, 2009
Page 1

High Velocity Hurricane Protection

NOTICE OF ACCEPTANCE: EVIDENCE SUBMITTED

A. DRAWINGS

1. Drawing No. **09-HVH-0001**, titled "Category 5 Rolling Hurricane Curtain", prepared by Engineering Express, sheets 1 through 5 of 5, dated 04/15/09, signed and sealed by Frank L. Bennardo, P.E.

B. TESTS

1. Test reports on Uniform Static Air Pressure Test per TAS 202 of Category 5 Dual End Retention Rolling Hurricane Curtain, prepared by Hurricane Engineering & Testing, Inc., Report No. **HETI-09-2503A**, dated 01/30/09, signed and sealed by Candido F. Font, P.E.
2. Test reports on Large Missile Impact Test per TAS 201-94 and Cyclic Wind Loading Test per TAS 203-94 of Category 5 Dual End Retention Rolling Hurricane Curtain, prepared by Hurricane Engineering & Testing, Inc., Report No. **HETI-09-2503B**, dated 01/30/09, signed and sealed by Candido F. Font, P.E.
3. Test reports on Uniform Static Air Pressure Test per TAS 202 of Category 5 Dual End Retention Rolling Hurricane Curtain, prepared by Hurricane Engineering & Testing, Inc., Report No. **HETI-09-2504A**, dated 01/30/09, signed and sealed by Candido F. Font, P.E.
4. Test reports on Large Missile Impact Test per TAS 201-94 and Cyclic Wind Loading Test per TAS 203-94 of Category 5 Dual End Retention Rolling Hurricane Curtain, prepared by Hurricane Engineering & Testing, Inc., Report No. **HETI-09-2504B**, dated 01/30/09, signed and sealed by Candido F. Font, P.E.
5. Test reports on Uniform Static Air Pressure Test per TAS 202 of Category 5 Dual End Retention Rolling Hurricane Curtain, prepared by Hurricane Engineering & Testing, Inc., Report No. **HETI-09-2505A**, dated 01/30/09, signed and sealed by Candido F. Font, P.E.
6. Test reports on Large Missile Impact Test per TAS 201-94 and Cyclic Wind Loading Test per TAS 203-94 of Category 5 Dual End Retention Rolling Hurricane Curtain, prepared by Hurricane Engineering & Testing, Inc., Report No. **HETI-09-2505B**, dated 01/30/09, signed and sealed by Candido F. Font, P.E.
7. Test report on Tensile Test of Category 5 Dual End Retention Rolling Hurricane Curtain Slats, Test Report No. **HETI-09-T100**, prepared by Hurricane Engineering & Testing, Inc., dated 01/30/09, signed and sealed by Candido F. Font, P.E.



7/22/09

Carlos M. Utrera, P.E.
Product Control Examiner
NOA No. 09-0511.02
Expiration Date: August 12, 2014
Approval Date: August 12, 2009

High Velocity Hurricane Protection

NOTICE OF ACCEPTANCE: EVIDENCE SUBMITTED

C. CALCULATIONS

1. Anchoring calculations and comparative analysis prepared Engineering Express, sheets 1 through 10 of 10, signed and sealed by Frank L. Bennardo, P.E.

D. QUALITY ASSURANCE

1. Miami Dade Building Code Compliance Office (BCCO).

E. MATERIAL CERTIFICATIONS

1. None.

F. STATEMENTS

1. Code compliance letter issued by Engineering Express, dated 05/05/09, signed and sealed by Frank L. Bennardo, PE.
2. No financial interest letter issued by Engineering Express, dated 05/05/09, signed and sealed by Frank L. Bennardo, P.E.

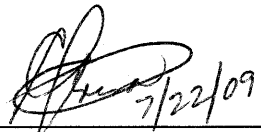

Handwritten signature of Carlos M. Utrera, P.E., dated 7/22/09.

Carlos M. Utrera, P.E.
Product Control Examiner
NOA No. 09-0511.02
Expiration Date: August 12, 2014
Approval Date: August 12, 2009

CATEGORY 5 ROLLING HURRICANE CURTAIN

LARGE MISSILE IMPACT RESISTANT
FOR USE WITHIN AND OUTSIDE THE HVHZ

FRANK L. BENNARDO, P.E.
PE0046549

05/05/2009

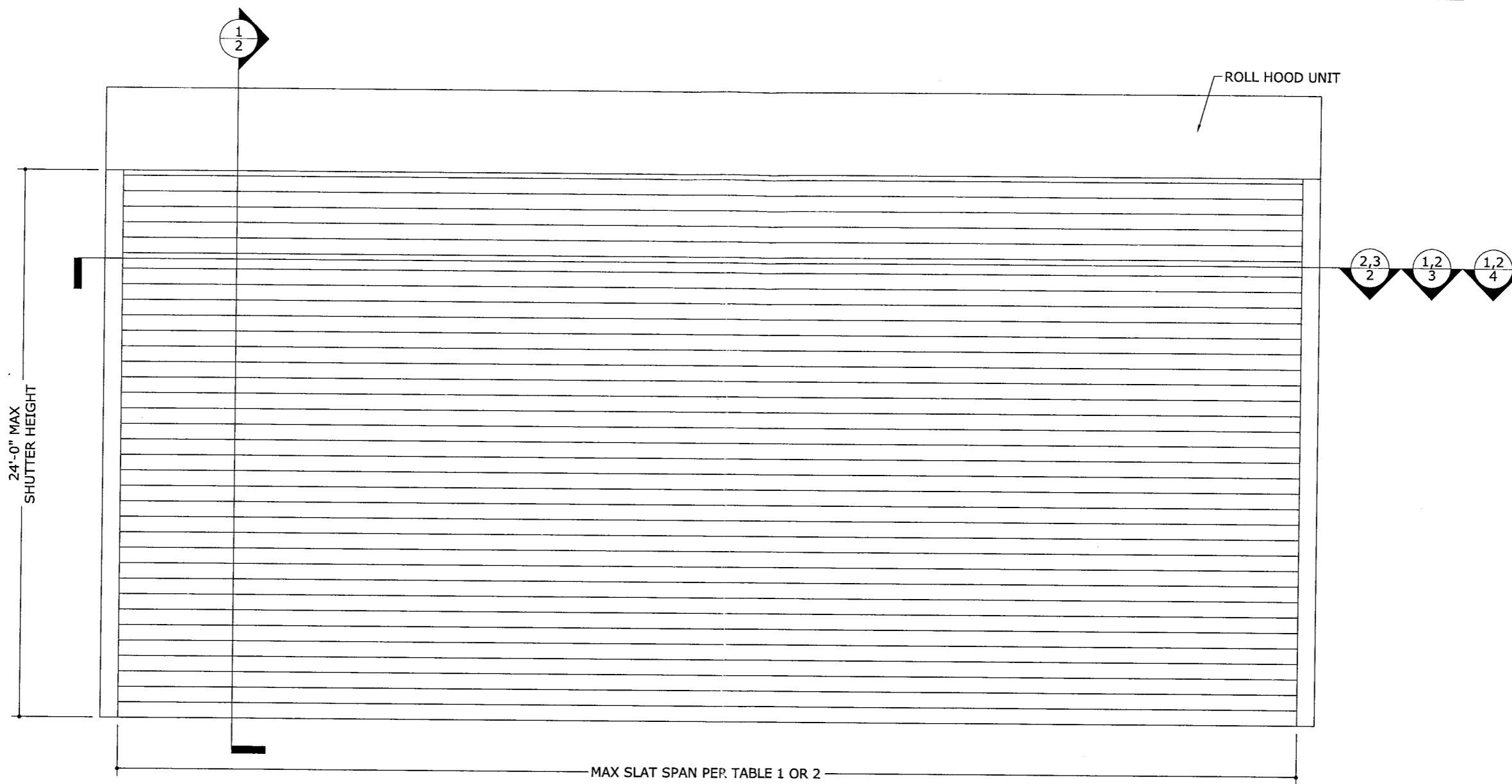

1 TYPICAL ELEVATION
1 N.T.S. EXTERIOR ELEV

GENERAL NOTES

1. THE SYSTEM DESCRIBED HEREIN HAS BEEN DESIGNED AND TESTED AS AN IMPACT RESISTANT HURRICANE ABATEMENT PRODUCT IN ACCORDANCE WITH THE 2007 FLORIDA BUILDING CODE, FOR USE INSIDE AND OUTSIDE THE HIGH VELOCITY HURRICANE ZONE, PER TAS 201 / 202 / 203 TEST STANDARDS.
2. NO 33-1/3% INCREASE IN ALLOWABLE STRESS HAS BEEN USED IN THE DESIGN OF THIS SYSTEM.
3. POSITIVE AND NEGATIVE DESIGN PRESSURES CALCULATED FOR USE WITH THIS SYSTEM SHALL BE DETERMINED BY OTHERS ON A JOB-SPECIFIC BASIS IN ACCORDANCE WITH THE GOVERNING CODE.
4. THE SYSTEM DETAILED HEREIN IS GENERIC AND DOES NOT PROVIDE INFORMATION FOR A SPECIFIC SITE. FOR SITE CONDITIONS DIFFERENT FROM THE CONDITIONS DETAILED HEREIN, A LICENSED ENGINEER OR REGISTERED ARCHITECT SHALL PREPARE SITE SPECIFIC DOCUMENTS FOR USE IN CONJUNCTION WITH THIS DOCUMENT.
5. PERMIT HOLDER SHALL VERIFY THE ADEQUACY OF THE EXISTING STRUCTURE TO WITHSTAND SUPERIMPOSED LOADS.
6. ALL EXTRUSIONS SHALL BE OF THE MATERIALS INDICATED HEREIN.
7. ALL BOLTS & WASHERS SHALL BE ZINC COATED STEEL, GALVANIZED STEEL, OR STAINLESS STEEL WITH A MINIMUM TENSILE YIELD STRENGTH OF 60 KSI.
8. ALL STEEL IN CONTACT WITH ALUMINUM SHALL BE PAINTED OR PLATED.

ENGINEERING EXPRESS
160 SW 12th AVENUE, # 106
DEERFIELD BEACH, FL 33442
PH: (954) 354-0660 FAX: (954) 354-0443
WWW.ENGEXP.COM
CERT. OF AUTH #9886
A FRANK L. BENNARDO, P.E., INC. INNOVATION

HIGH VELOCITY HURRICANE
3390 MERCANTILE AVENUE
NAPLES, FL 34104
PHONE: (239) 403-2650
CATEGORY 5 ROLLING HURRICANE CURTAIN
LARGE MISSILE IMPACT RESISTANT
FOR USE WITHIN AND OUTSIDE THE HVHZ

REMARKS	DRWN	CHKD	DATE
INIT ISSUE	RKB	CL	04/15/09

09-HVH-0001

SCALE: 01
PAGE DESCRIPTION:

Approved as complying with the
Florida Building Code
Date 08/12/2009
NOA# 09-0511-02
Miami Dade Product Control
Division
By *[Signature]*

05/05/2009 - 12:09pm rbarlett F:\01 Project Files\High Velocity Hurricane (HVH)\2009\09-HVH-0001 End-Retention Roll-Up Shutter (NOA & FSA)\09-HVH-0001_01c End-Retention Roll-Up (NOA).dwg

05/05/2009 - 12:08pm rbarlett F:\01 Project Files\High Velocity Hurricane (HVH)\2009\09-HVH-0001 End-Retention Roll-Up Shutter (NOA & FSA)\09-HVH-0001_01c End-Retention Roll-Up (NOA).dwg

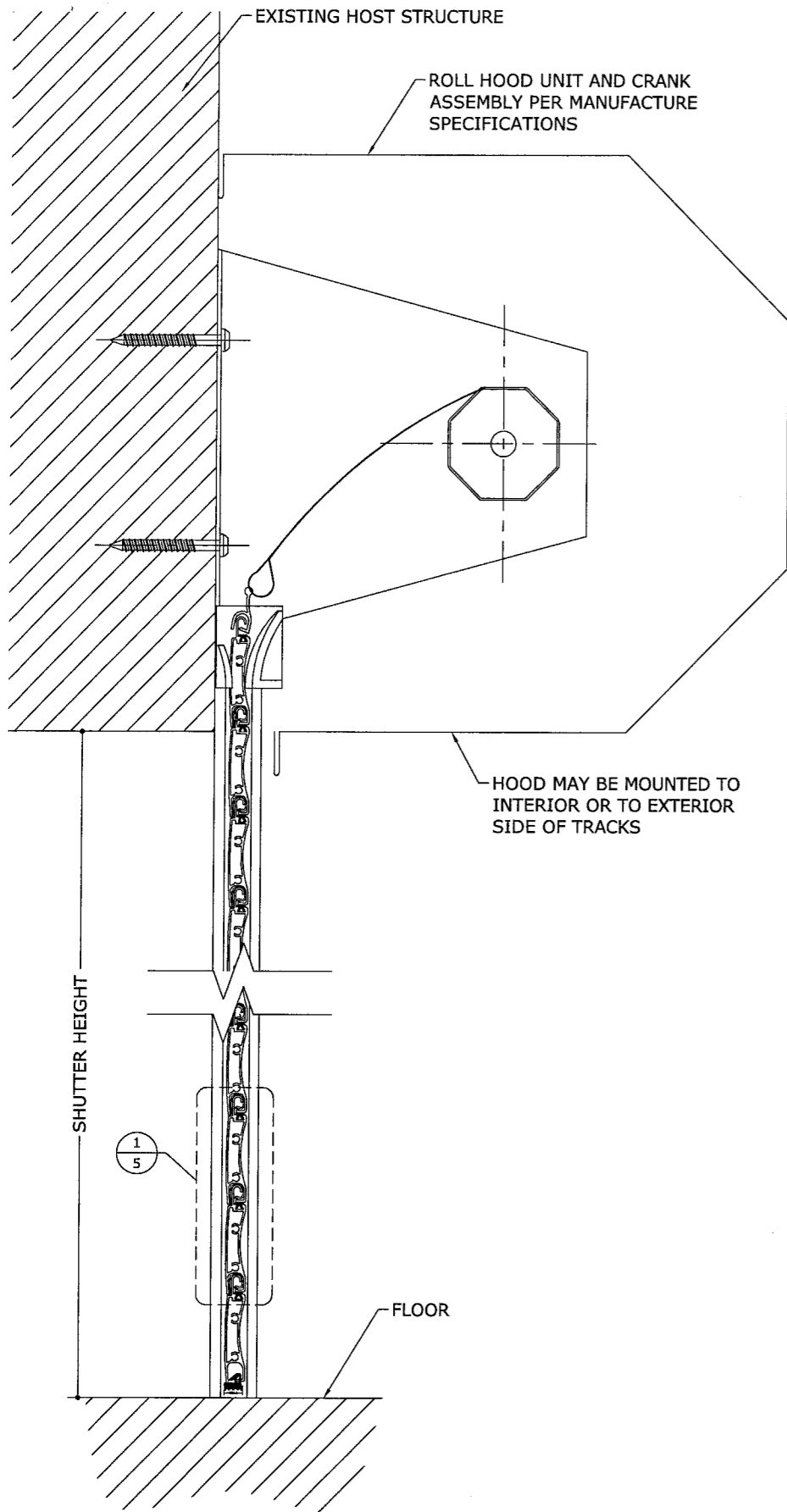

1 TYPICAL SECTION
2 N.T.S. VERT SECTION

ANCHORS PER TABLE 1,
 1 3/4" FROM ENDS AND
 3" O.C. (TYP)

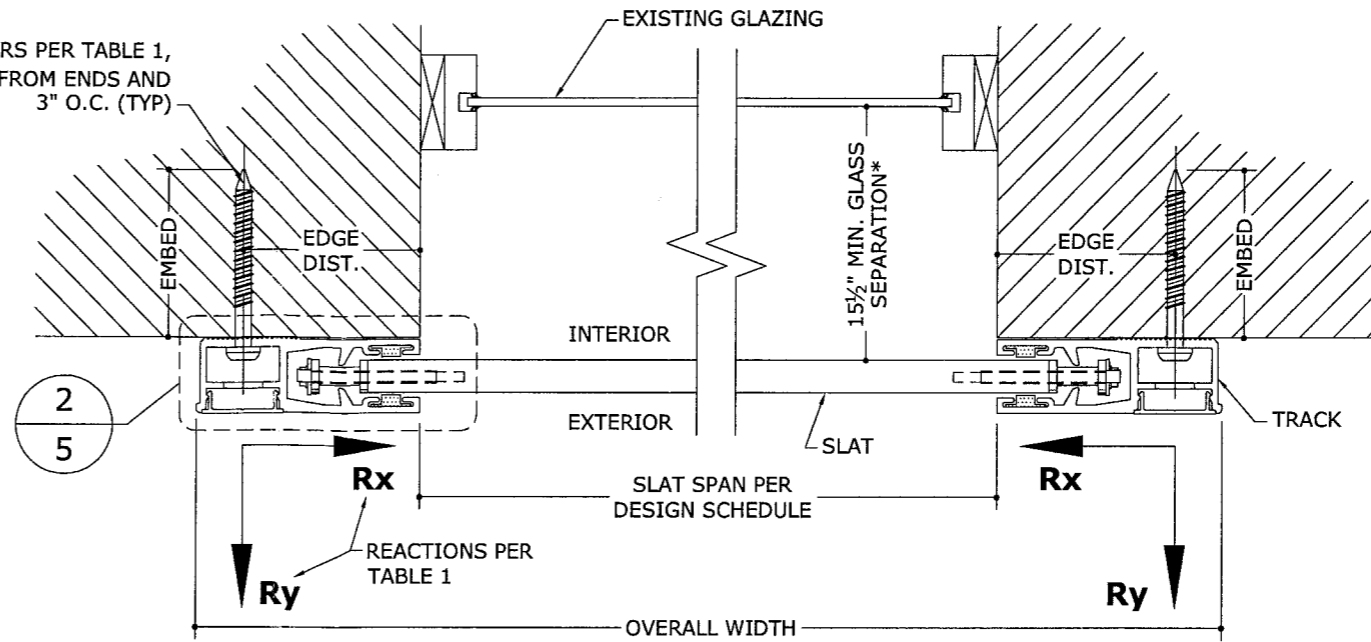

2 TYPICAL EXTERIOR MOUNT
2 N.T.S. HORIZ SECTION

*NOTE: NO MINIMUM SEPARATION
 FROM GLASS REQUIRED FOR USE
 OUTSIDE THE HVHZ.

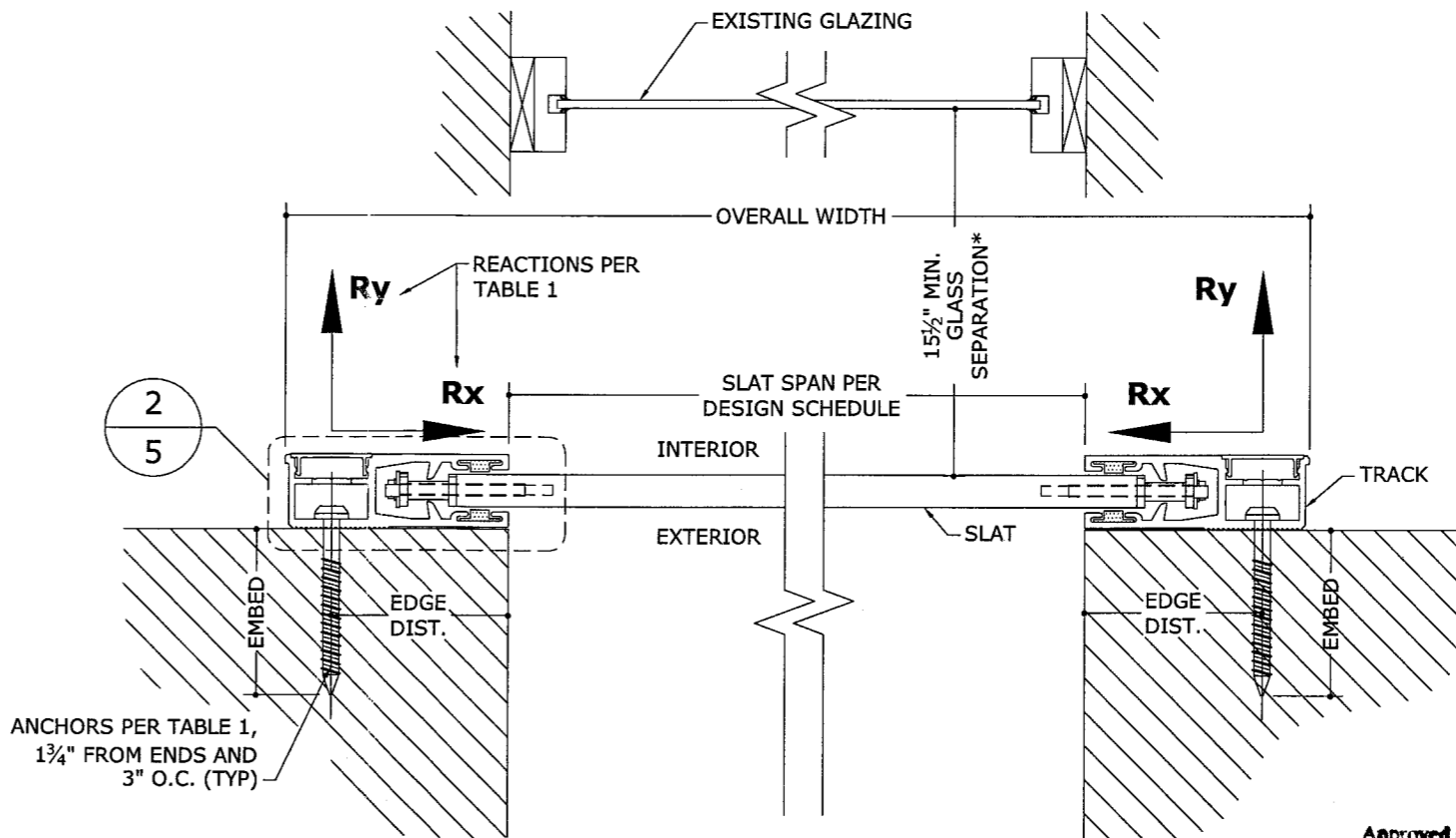

3 TYPICAL INTERIOR MOUNT
2 N.T.S. HORIZ SECTION

Approved as complying with the
 Florida Building Code
 Date 08/12/2009
 NOA# 09-0571-02
 Miami Dade Product Control
 Division
 by *[Signature]*

FRANK L. BENNARDO, P.E.
 #PE0046549

05/05/2009



160 SW 12th AVENUE, #106
 DEERFIELD BEACH, FL 33442
 PH: (954) 354-0660 FAX: (954) 354-0443
 WWW.ENGEXP.COM
 CERT OF AUTH #8885
 A FRANK L. BENNARDO, P.E., INC. INNOVATION

HIGH VELOCITY HURRICANE

3390 MERCANTILE AVENUE
 NAPLES, FL 34104
 PHONE: (239) 403-2650

CATEGORY 5 ROLLING HURRICANE CURTAIN
 LARGE MISSILE IMPACT RESISTANT
 FOR USE WITHIN AND OUTSIDE THE HVHZ

REMARKS	DRWN	CHKD	DATE
INIT ISSUE	RKB	CL	04/15/09

09-HVH-0001
 SCALE: 1/8" = 1'-0"
 PAGE DESCRIPTION: 01

F:\01 Project Files\High Velocity Hurricane (HVH)\2009\09-HVH-0001 End-Retention Roll-Up Shutter (NOA & FSA)\09-HVH-0001_01c End-Retention Roll-Up (NOA).dwg

ANCHORS PER TABLE 2,
1 3/4" FROM ENDS AND
3" O.C. (TYP)

2
5

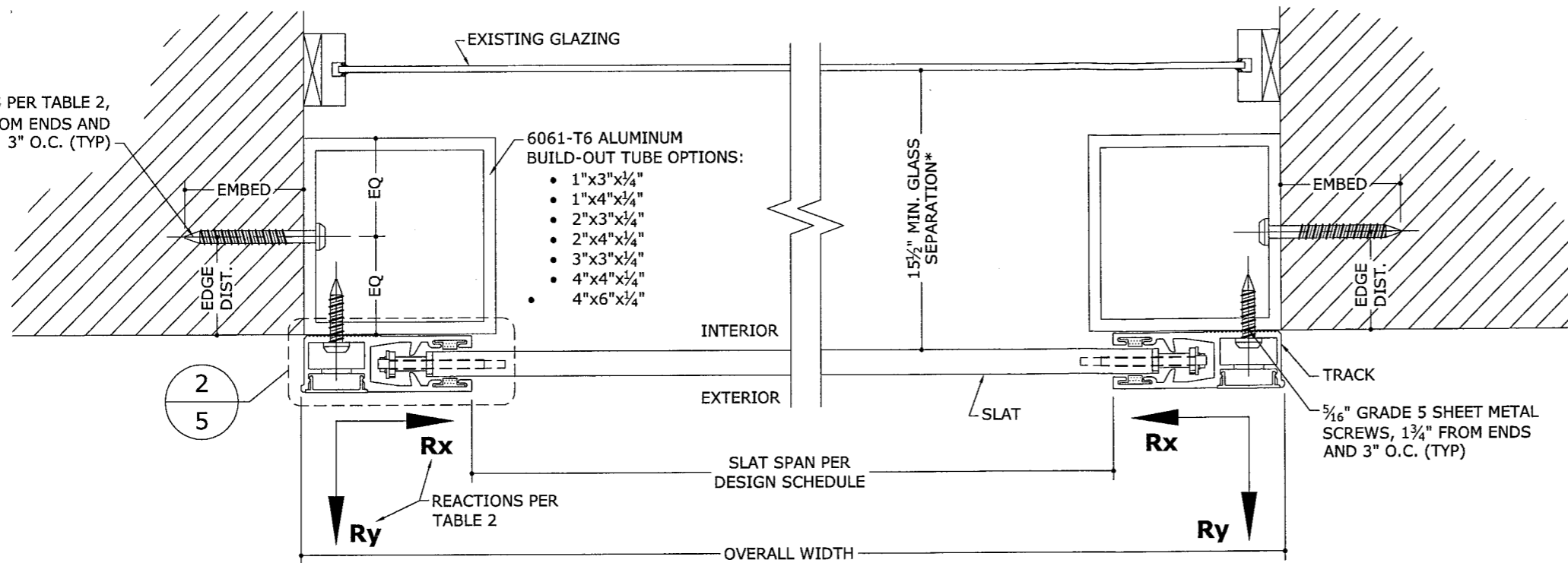

1
3

TYPICAL EXTERIOR BUILD-OUT TUBE MOUNT

N.T.S. HORIZ SECTION

*NOTE: NO MINIMUM SEPARATION FROM GLASS REQUIRED FOR USE OUTSIDE THE HVHZ.

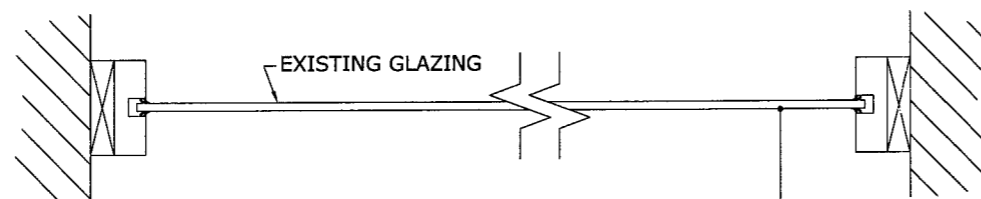

ANCHORS PER TABLE 2,
1 3/4" FROM ENDS AND
3" O.C. (TYP)

2
5

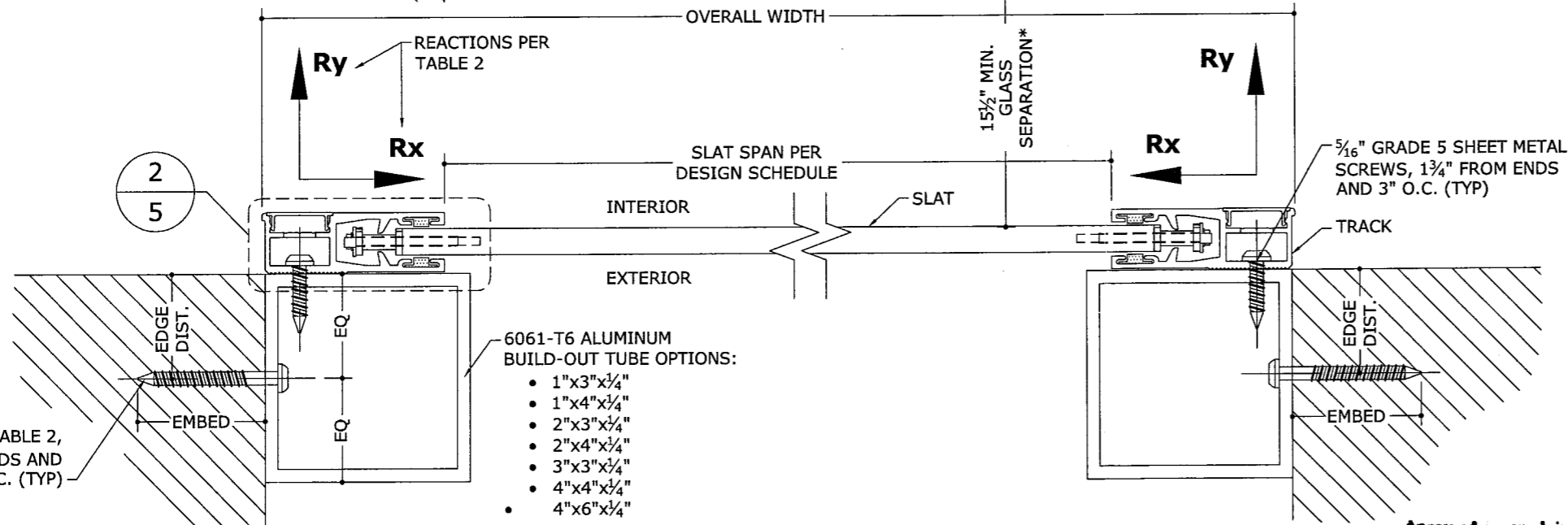

2
3

TYPICAL INTERIOR BUILD-OUT TUBE MOUNT

N.T.S. HORIZ SECTION

Approved as complying with the
Florida Building Code
Date 08/12/2009
NOA# 29-0511-02
Miami Dade Product Control
Division
By [Signature]

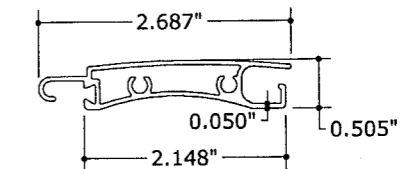

3
3

SLAT
6063-T6 ALUM. ALLOY
6" = 1'-0"

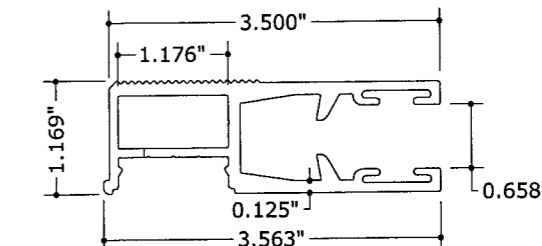

4
3

TRACK
6063-T6 ALUM. ALLOY
6" = 1'-0"

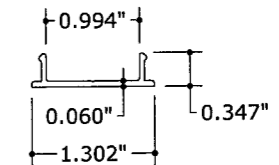

5
3

TRACK COVER
6063-T5 ALUM. ALLOY
6" = 1'-0"

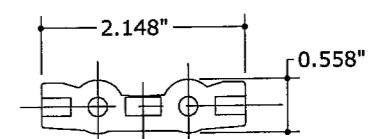

6
3

WINDLOCK
REINF. NYLON (MFD BY M&M PLASTICS)
6" = 1'-0"

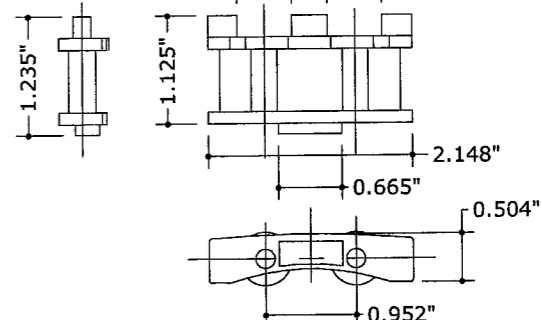

FRANK L. BENNARDO, P.E.
#BF0046549

05/05/2009

ENGINEERING EXPRESS
160 SW 12th AVENUE, # 106
DEERFIELD BEACH, FL 33442
Ph: (954) 354-0660 Fax: (954) 354-0443
WWW.ENGEXP.COM
CERT OF AUTH #885
A FRANK L. BENNARDO, P.E., INC. INNOVATION

HIGH VELOCITY HURRICANE
3390 MERCANTILE AVENUE
NAPLES, FL 34104
PHONE: (239) 403-2650
CATEGORY 5 ROLLING HURRICANE CURTAIN
LARGE MISSILE IMPACT RESISTANT
FOR USE WITHIN AND OUTSIDE THE HVHZ

DATE	DRWN	CHKD	CL
04/15/09	RKB		

09-HVH-0001
SCALE: 1/8" = 1'-0"
PAGE DESCRIPTION:

3

05/05/2009 - 12:09pm rbartlett F:\01 Project Files\High Velocity Hurricane (HVH)\2009\09-HVH-0001 End-Retention Roll-Up Shutter (NOA & FSA)\09-HVH-0001_01c End-Retention Roll-Up (NOA).dwg

05/05/2009



160 SW 12th AVENUE, #106
DEERFIELD BEACH, FL 33442
Ph: (954) 354-0660 Fax: (954) 354-0443
WWW.ENGEXP.COM

CERT OF AUTH #9885
A. FRANK L. BENNARDO, P.E., INC. INNOVATION

HIGH VELOCITY HURRICANE

3390 MERCANTILE AVENUE
NAPLES, FL 34104
PHONE: (239) 403-2650

CATEGORY 5 ROLLING HURRICANE CURTAIN
LARGE MISSILE IMPACT RESISTANT
FOR USE WITHIN AND OUTSIDE THE HVHZ

DRWN	CHKD	DATE
RKB	CL	04/15/09

09-HVH-0001

SCALE: 01
PAGE DESCRIPTION:

4

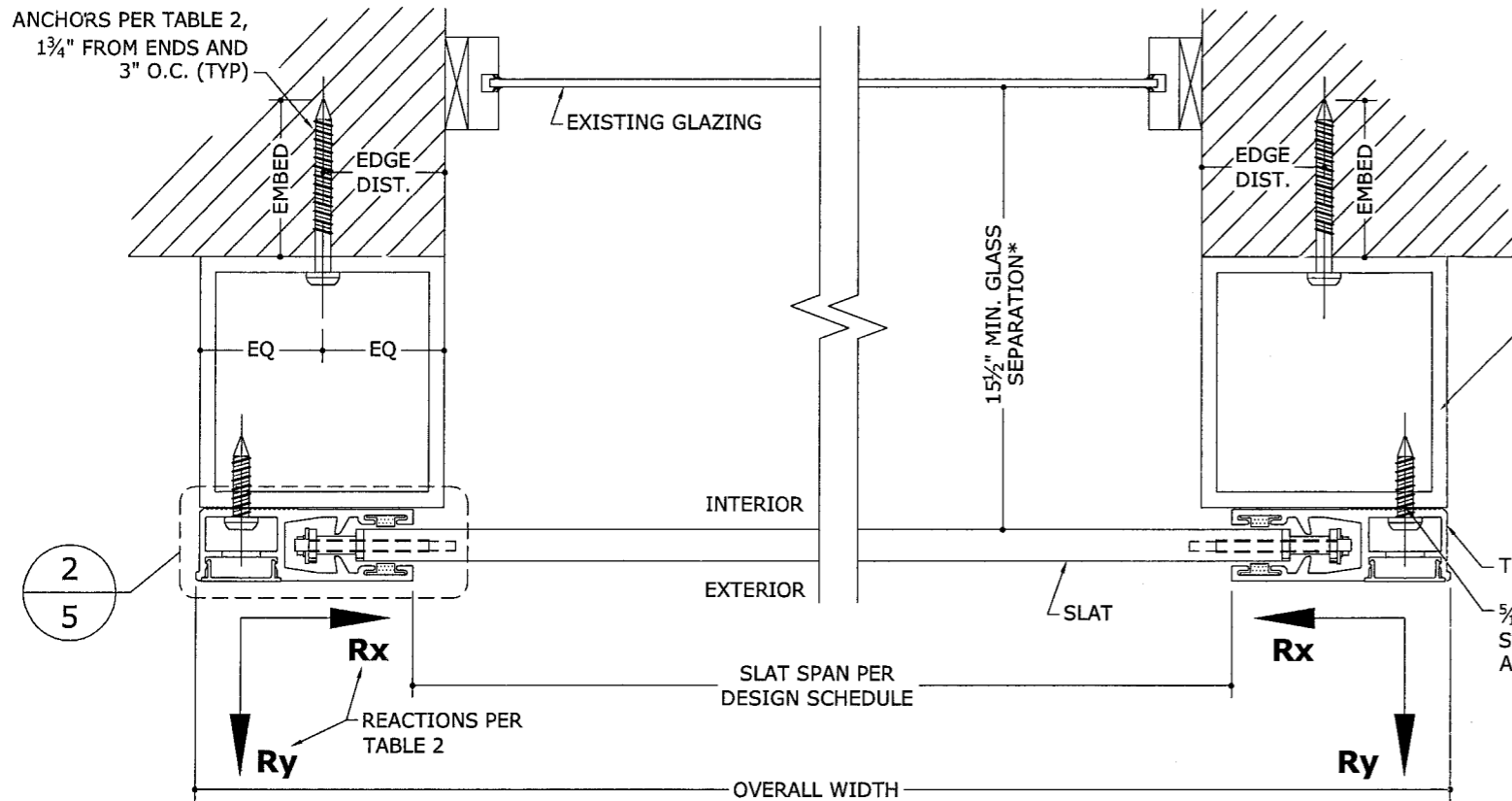

1
4
TYPICAL EXTERIOR BUILD-OUT TUBE MOUNT
N.T.S. HORIZ SECTION

*NOTE: NO MINIMUM SEPARATION FROM GLASS REQUIRED FOR USE OUTSIDE THE HVHZ.

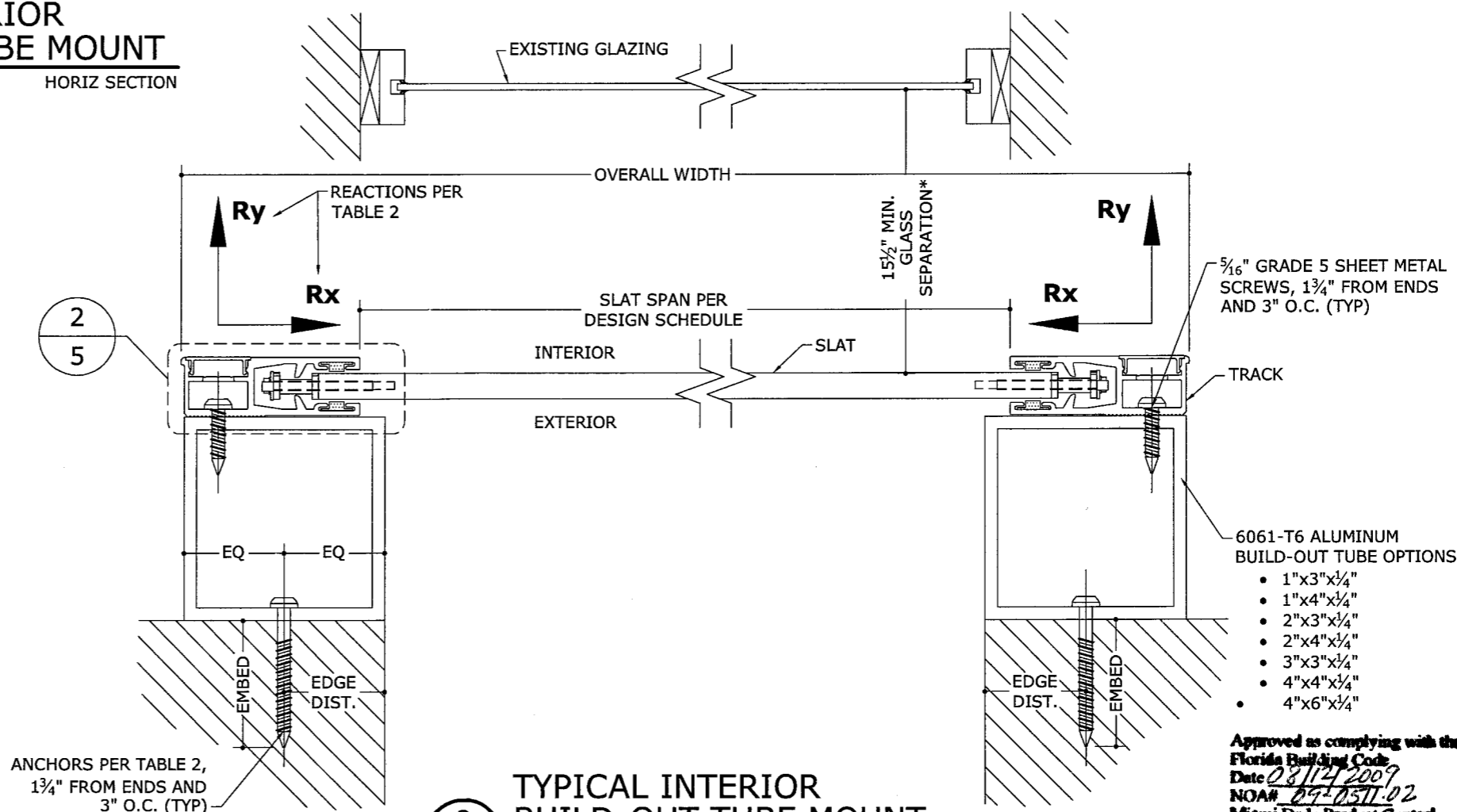

2
4
TYPICAL INTERIOR BUILD-OUT TUBE MOUNT
N.T.S. HORIZ SECTION

Approved as complying with the Florida Building Code
Date 08/14/2009
NOA# 09-0371-02
Miami Dade Product Control Division
By [Signature]

05/05/2009 - 12:09pm rbarlett F:\01 Project Files\High Velocity Hurricane (HVH)\2009\09-HVH-0001 End-Retention Roll-Up Shutter (NOA & FSA)\09-HVH-0001_01c End-Retention Roll-Up (NOA).dwg

TABLE 1: DIRECT MOUNT INSTALLATION

SUBSTRATE	ANCHOR TYPE	SLAT SPAN											
		12'-0"				16'-0"				20'-0"			
		ALLOWABLE DESIGN PRESSURES (PSF)		REACTIONS (LB/FT)		ALLOWABLE DESIGN PRESSURES (PSF)		REACTIONS (LB/FT)		ALLOWABLE DESIGN PRESSURES (PSF)		REACTIONS (LB/FT)	
+	-	Ry	Rx	+	-	Ry	Rx	+	-	Ry	Rx		
A36 STEEL (3/16" MIN)	5/16" GRADE 5 SHEET METAL SCREW	80.0	80.0	480.0	2560.0	80.0	80.0	640.0	3014.7	61.7	56.2	617.2	3828.9
6061-T6 ALUMINIUM (1/4" MIN)	5/16" GRADE 5 SHEET METAL SCREW	80.0	80.0	480.0	2560.0	70.3	73.1	585.0	2647.5	44.7	40.7	447.5	2772.6
CONCRETE (2899 PSI MIN)	5/16" ITW TAPCON WITH 2-1/4" MIN EMBED AND 3-1/8" MIN EDGE DISTANCE	59.2	59.6	357.7	1895.7	49.3	51.3	410.5	1859.6	31.6	28.7	315.6	1958.4
	3/8" POWERS WEDGE-BOLT WITH 3-1/2" MIN EMBED AND 3" MIN EDGE DISTANCE	80.0	80.0	480.0	2560.0	80.0	80.0	640.0	3014.7	50.5	45.7	504.6	3113.5
GROUT-FILLED BLOCK	5/16" ITW TAPCON WITH 2-1/4" MIN EMBED AND 4" MIN EDGE DISTANCE	67.9	68.3	410.0	2172.5	56.6	58.9	471.5	2134.4	36.1	32.8	361.1	2238.4

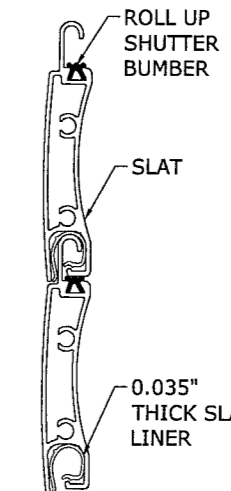

1 SLAT ASSEMBLY
6" = 1'-0" VERT SECTION

TABLE 2: BUILD-OUT TUBE MOUNT INSTALLATION

SUBSTRATE	ANCHOR TYPE	SLAT SPAN											
		12'-0"				16'-0"				20'-0"			
		ALLOWABLE DESIGN PRESSURES (PSF)		REACTIONS (LB/FT)		ALLOWABLE DESIGN PRESSURES (PSF)		REACTIONS (LB/FT)		ALLOWABLE DESIGN PRESSURES (PSF)		REACTIONS (LB/FT)	
+	-	Ry	Rx	+	-	Ry	Rx	+	-	Ry	Rx		
A36 STEEL (3/16" MIN)	5/16" GRADE 5 SHEET METAL SCREW	80.0	80.0	480.0	2560.0	70.3	73.1	585.0	2647.5	44.7	40.7	447.5	2772.6
6061-T6 ALUMINIUM (1/4" MIN)	5/16" GRADE 5 SHEET METAL SCREW	80.0	80.0	480.0	2560.0	70.3	73.1	585.0	2647.5	44.7	40.7	447.5	2772.6
CONCRETE (2899 PSI MIN)	5/16" ITW TAPCON WITH 2-1/4" MIN EMBED AND 3-1/8" MIN EDGE DISTANCE	59.2	59.6	357.7	1895.7	49.3	51.3	410.5	1859.6	31.6	28.7	315.6	1958.4
	3/8" POWERS WEDGE-BOLT WITH 3-1/2" MIN EMBED AND 3" MIN EDGE DISTANCE	80.0	80.0	480.0	2560.0	70.3	73.1	585.0	2647.5	44.7	40.7	447.5	2772.6
GROUT-FILLED BLOCK	5/16" ITW TAPCON WITH 2-1/4" MIN EMBED AND 4" MIN EDGE DISTANCE	67.9	68.3	410.0	2172.5	56.6	58.9	471.5	2134.4	36.1	32.8	361.1	2238.4

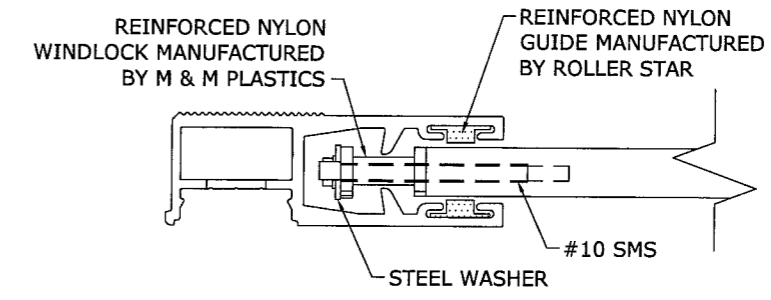

2 TRACK ASSEMBLY
6" = 1'-0" HORIZ SECTION

TABLE NOTES:

1. DETERMINE WHICH MOUNTING CONDITION IS APPLICABLE AND SELECT TABLE 1 OR 2 ACCORDINGLY.
2. TO DETERMINE THE ALLOWABLE DESIGN PRESSURES AND REACTIONS, MATCH THE ANCHOR TYPE WITH THE CORRESPONDING SLAT SPAN.
3. ANCHORS SHALL BE INSTALLED IN ACCORDANCE WITH MANUFACTURERS' RECOMMENDATIONS.
4. EDGE DISTANCE OF 1/2" IS ACCEPTABLE FOR ANCHORS TO STEEL OR ALUMINUM.
5. MINIMUM EMBEDMENT SHALL BE AS NOTED IN ANCHOR SCHEDULE. MINIMUM EMBEDMENT AND EDGE DISTANCE EXCLUDES STUCCO, FOAM, BRICK, AND OTHER WALL FINISHES.
6. MACHINE SCREWS SHALL BE INSTALLED WITH FULL ENGAGEMENT OF THREADS INTO METAL HOST STRUCTURE AND MAY HAVE EITHER A FLAT HEAD, PAN HEAD, TRUSS HEAD, OR OTHER HEAD STYLES.

Approved as complying with the Florida Building Code
 Date 08/12/2009
 NOAH 02-0511.02
 Miami Dade Product Control Division
 By *[Signature]*

FRANK L. BENNARDO, P.E.
 #PE0046549
 05/05/2009
ENGINEERING EXPRESS
 160 SW 12th AVENUE, #106
 DEERFIELD BEACH, FL 33442
 PH: (954) 354-0660 FAX: (954) 354-0443
 WWW.ENGEXP.COM
 CERT OF AUTH #9885
 A. FRANK L. BENNARDO, P.E., INC. INNOVATION

HIGH VELOCITY HURRICANE
 3390 MERCANTILE AVENUE
 NAPLES, FL 34104
 PHONE: (239) 403-2650
 CATEGORY 5 ROLLING HURRICANE CURTAIN
 LARGE MISSILE IMPACT RESISTANT
 FOR USE WITHIN AND OUTSIDE THE HVHZ

DRWN	CHKD	DATE
RBK	CL	04/15/09

REMARKS
 INIT ISSUE

09-HVH-0001
 SCALE: 1/8" = 1'-0"
 PAGE DESCRIPTION:
 5